

TECTUS®

The completely concealed hinge system



INDEX

TECTUS® – The completely concealed hinge system

Model versions from 40 to 300 kg

6	TE 240 3D	40 kg	for unrebated and rebated flush residential doors
7	TE 340 3D	80 kg	for unrebated residential and heavy-duty doors
8	TE 526 3D	120 kg	made of solid stainless steel for unrebated heavy-duty doors
9	TE 527 3D	120 kg	made of solid steel for unrebated heavy-duty doors
10	TE 540 3D	120 kg	for unrebated heavy-duty doors
11	TE 640 3D	200 kg	for unrebated high performance heavy-duty doors
12	TE 645 3D	300 kg	for unrebated high performance heavy-duty doors

Model versions for specific scope of applications

16	TECTUS® Energy		with permanent energy transfer
18	TE 541 3D FVZ	100 kg	for unrebated residential and heavy-duty doors with recessed frame facings
20	TECTUS® A8		for unrebated heavy-duty doors with claddings up to 8 mm
22	TECTUS® FR		Fire rated with integrated intumescent kit
24	TE 380 3D	60 kg	for rebated residential doors

Fixing plates and receivers

26	TE ... 3D FZ		Fixing plate for residential and heavy-duty doors on casing frames
27	TE ... 3D SZ		Receiver for residential and heavy-duty doors on steel frames

28 Assembly

30 Routing data

35 Service

TECHNICAL FEATURES

The TECTUS-brand fully concealed hinge system has been an integral part of the SIMONSWERK range since 2002. Thanks to its ongoing development, TECTUS is today more innovative and efficient than ever.

With the TECTUS hinge system, any door, from high-quality interior doors to large, heavy-duty doors, can be integrated into straight-lined and flush-fitting architectural structures. This well-established series has a wide range of applications, such as flush-fitting models for invisible frames, versions with built-in fire protection or designs with integrated energy transfer.

Its ability to withstand loads from 40 to 300 kg, an opening angle of 180 degrees, the use of frames in wood, steel and aluminium, its 3D adjustability, and maintenance-free slide bearings make TECTUS an exceptional hinge solution, both technically and aesthetically.

TECTUS® - THE FULLY CONCEALED HINGE SYSTEM

- › for flush-fitting architectural structures
 - › with a load capacity of 40 to 300 kg
 - › with an opening angle of 180°
 - › for unrebated and rebated, flush-mounted doors
 - › for rebated doors
 - › for wood, steel and aluminium frames
 - › with maintenance-free slide bearing technology
-



DESIGN MEETS FUNCTION.

A FULL RANGE OF CONCEALED HINGES

For applications ranging from high-quality interior doors to heavy sound-proof doors with special requirements in terms of load and performance, SIMONSWERK has for years provided a comprehensive product range including a wide choice of its fully concealed TECTUS brand.

All the models in the TECTUS-brand fully concealed hinge range for high-quality interior and functional heavy-duty doors have the same technical and visual features, and can be used with wood, steel and aluminium frames. They all have a uniform appearance, with a closed hinge body that hides the milling from view, and are available in a range of materials and attractive surface finishes.



TE 240 3D

Load capacity
up to 40 kg



TE 340 3D

Load capacity
up to 80 kg



**Versions for special applications
from page 14.**



TE 526 3D

Load capacity
up to 120 kg



TE 527 3D

Load capacity
up to 120 kg



TE 540 3D

Load capacity
up to 120 kg



TE 640 3D

Load capacity
up to 200 kg



TE 645 3D

Load capacity
up to 300 kg

TECTUS®

TE 240 3D

for unrebated and rebated flush residential doors

Hinge **up to 40 kg**

Product features

- completely concealed hinge system
- for timber, steel or aluminium frames
- for unrebated and rebated flush residential doors
- sideways closed hinge body for a homogeneous mortise appearance
- with comfortable 3D adjustment (side +/- 3.0 mm, height +/- 3.0 mm, compression +/- 1.5 mm)
- maintenance-free slide bearings

Technical Data

Load capacity	i 2 hinges per door leaf (1x2m)	40.0 kg
Overall length		155.0 mm
Width (frame)		21.0 mm
Width (door)		18.0 mm
Cutter diameter		16.0 mm
Opening angle		180°

Finish

satin chrome look (F1), satin nickel look (F2), stainless steel look, polished brass, polished nickelled, bronze metallic, bronze finish, bronze finish light, bronze finish dark, powder-coated, other finishes available upon request

Combination

Receiver	Casing frame	TE 240 3D FZ/1
	Steel frame	TE 240 3D SZ

Installation Tools

Jig		Universal milling frame
Frame	Template	No. 5 250691 6
Door	Template	No. 5 250692 6

Note

i The load capacity mentioned above refers to the use of 2 hinges per door leaf (1 x 2 m).

Classification key

2	7	2	0	1	*	0	7
---	---	---	---	---	---	---	---

*depending on the finish

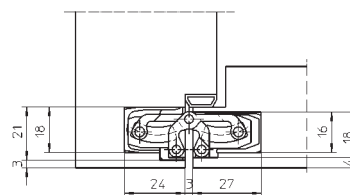
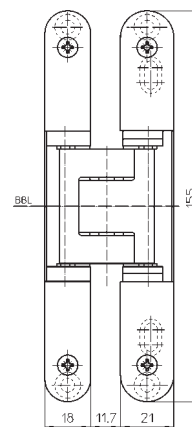



TE 340 3D

for unrebated residential and heavy-duty doors

Hinge		up to 80 kg
--------------	--	--------------------

Product features

- completely concealed hinge system
- for timber, steel or aluminium frames
- for unrebated residential and heavy duty doors
- sideways closed hinge body for a homogeneous mortise appearance
- with comfortable 3D adjustment (side +/- 3.0 mm, height +/- 3.0 mm, compression +/- 1.0 mm)
- maintenance-free slide bearings

Technical Data

Load capacity	i 2 hinges per door leaf (1x2m)	80.0 kg
Overall length		160.0 mm
Width (frame)		28.0 mm
Width (door)		28.0 mm
Cutter diameter		24.0 mm
Opening angle		180°

Finish

satin chrome look (F1), satin nickel look (F2), stainless steel look, polished brass, polished nickelled, bronze metallic, bronze finish, bronze finish light, bronze finish dark, powder-coated, other finishes available upon request

Combination

Receiver	Casing frame	TE 340 3D FZ/1
	Steel frame	TE 340 3D SZ

Installation Tools

Jig		Universal milling frame
Step 1	Template	No. 5 250693 5
Step 2	Template	No. 5 250694 5

Functional areas

Fire resistance, Smoke resistance, Burglar resistance

Note

i The load capacity mentioned above refers to the use of 2 hinges per door leaf (1 x 2 m).

Classification key

3	7	4	1	1	*	0	11a
---	---	---	---	---	---	---	-----

*depending on the finish

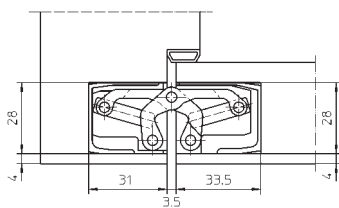
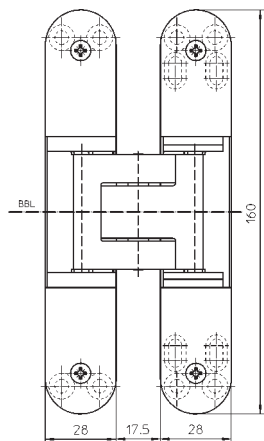

TECTUS®

TE 526 3D

made of solid stainless steel for unrebated heavy-duty doors

Hinge up to 120 kg

Product features

- Material stainless steel
- completely concealed hinge system
- for timber, steel or aluminium frames
- for unrebated residential and heavy duty doors
- 3D adjustable (side +/- 3.0 mm, height +/- 3.0 mm, compression +/- 1.0 mm)
- maintenance-free slide bearings

Technical Data

Load capacity	i 2 hinges per door leaf (1x2m)	120.0 kg
Overall length		155.0 mm
Width (frame)		26.0 mm
Width (door)		26.0 mm
Cutter diameter		24.0 mm
Opening angle		180°

Finish

Satin brushed stainless steel

Combination

Receiver	Casing frame	TE 526 3D FZ/1
	Steel frame	TE 526 3D SZ

Installation Tools

Jig		Universal milling frame
		Drilling jig TECTUS TE 526 3D
Frame/Door	Template	No. 5 250547 6

Functional areas

Fire resistance, Smoke resistance, Soundproof, Burglar resistance

Note

i The load capacity mentioned above refers to the use of 2 hinges per door leaf (1 x 2 m).

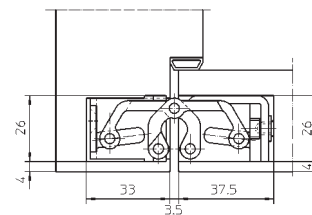
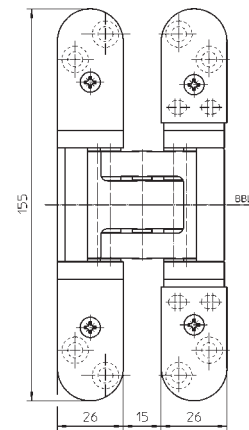

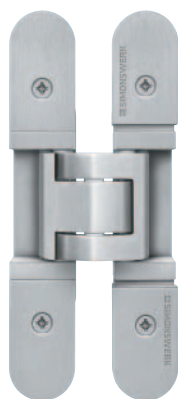

TE 527 3D

made of solid steel for unrebated heavy-duty doors

Hinge up to 120 kg

Product features

- Material solid steel
- completely concealed hinge system
- for timber, steel or aluminium frames
- for unrebated residential and heavy duty doors
- 3D adjustable (side +/- 3.0 mm, height +/- 3.0 mm, compression +/- 1.0 mm)
- maintenance-free slide bearings

Technical Data

Load capacity	i 2 hinges per door leaf (1x2m)	120.0 kg
Overall length		155.0 mm
Width (frame)		26.0 mm
Width (door)		26.0 mm
Cutter diameter		24.0 mm
Opening angle		180°

Finish

stainless steel look, other finishes available upon request

Combination

Receiver	Casing frame	TE 527 3D FZ/1
	Steel frame	TE 527 3D SZ
Intumescent kit on FD door sets		8820

Installation Tools

Jig	Universal milling frame
	Drilling jig TECTUS TE 527 3D
Frame/Door	Template
	No. 5 250547 6

Functional areas

Fire resistance, Smoke resistance, Soundproof, Burglar resistance

Note

i The load capacity mentioned above refers to the use of 2 hinges per door leaf (1 x 2 m).

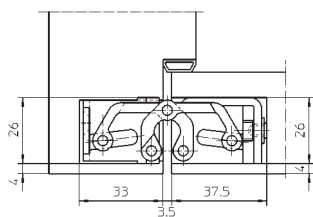
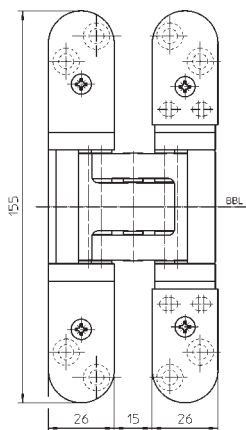

TECTUS®

TE 540 3D

for unrebated heavy-duty doors

Hinge up to 120 kg

Product features

- completely concealed hinge system
- for timber, steel or aluminium frames
- for unrebated heavy-duty doors
- sideways closed hinge body for a homogeneous mortise appearance
- with comfortable 3D adjustment (side +/- 3.0 mm, height +/- 3.0 mm, compression +/- 1.0 mm)
- maintenance-free slide bearings

Technical Data

Load capacity	i 2 hinges per door leaf (1x2m)	120.0 kg
Overall length		200.0 mm
Width (frame)		32.0 mm
Width (door)		32.0 mm
Cutter diameter		24.0 mm
Opening angle		180°

Finish

satin chrome look (F1), satin nickel look (F2), stainless steel look, polished brass, polished nickelled, powder-coated, other finishes available upon request

Combination

Receiver	Casing frame	TE 540 3D FZ/1
	Steel frame	TE 540 3D SZ

Installation Tools

Jig		Universal milling frame
Step 1	Template	No. 5 250680 5
Step 2	Template	No. 5 250681 5

Functional areas

Fire resistance, Smoke resistance, Soundproof, Burglar resistance

Note

i The load capacity mentioned above refers to the use of 2 hinges per door leaf (1 x 2 m).

Classification key

4	7	6	1	1	*	1	13
---	---	---	---	---	---	---	----

*depending on the finish

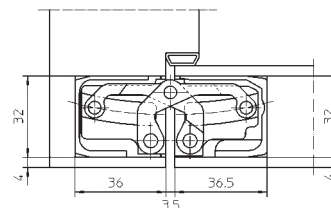
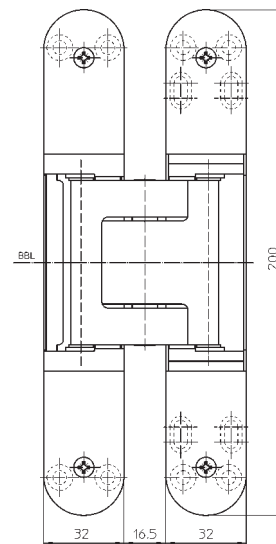



TE 640 3D

for unrebated high performance heavy-duty doors

Hinge		up to 200 kg
--------------	--	---------------------

Product features

- completely concealed hinge system
- for timber, steel or aluminium frames
- for unrebated high performance heavy-duty doors
- sideways closed hinge body for a homogeneous mortise appearance
- with comfortable 3D adjustment (side +/- 3.0 mm, height +/- 3.0 mm, compression +/- 1.0 mm)
- maintenance-free slide bearings

Technical Data

Load capacity	i 2 hinges per door leaf (1x2m)	200.0 kg
Overall length		240.0 mm
Width (frame)		32.0 mm
Width (door)		32.0 mm
Cutter diameter		24.0 mm
Opening angle		180°

Finish

satin chrome look (F1), satin nickel look (F2), stainless steel look, polished brass, polished nickelled, powder-coated, other finishes available upon request

Combination

Receiver	Casing frame	TE 640 3D FZ/1
	Steel frame	TE 640 3D SZ

Installation Tools

Jig		Universal milling frame
Step 1	Template	No. 5 250659 5
Step 2	Template	No. 5 250689 5

Functional areas

Fire resistance, Smoke resistance, Soundproof, Burglar resistance

Note

i The load capacity mentioned above refers to the use of 2 hinges per door leaf (1 x 2 m).

Classification key

4	7	8	1	1	*	1	15
---	---	---	---	---	---	---	----

*depending on the finish

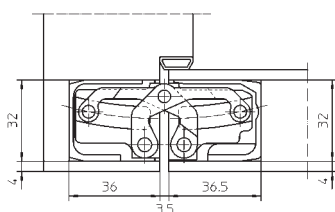
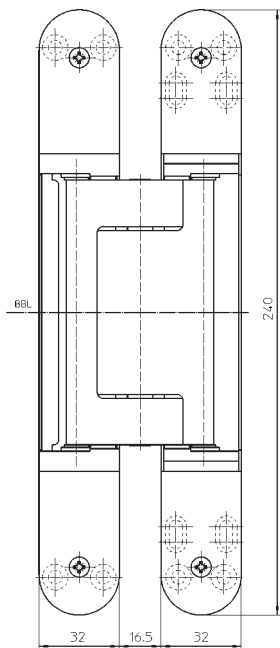

QUALITY MARKS



FUNCTIONAL AREAS



TECTUS®

TE 645 3D

for unrebuted high performance heavy-duty doors

Hinge up to 300 kg

Product features

- completely concealed hinge system
- for timber, steel and aluminium frames
- for unrebuted high performance heavy-duty doors
- sideways closed hinge body for a homogeneous mortise appearance
- with comfortable 3D adjustment (side +/- 3.0 mm, height +/- 3.0 mm, compression +/- 1.0 mm)
- maintenance-free slide bearings

Technical Data

Load capacity	i 2 hinges per door leaf (1x2m)	300.0 kg
Length (door)		280.0 mm
Length (frame)		260.0 mm
Width (frame)		36.0 mm
Width (door)		34.0 mm
Cutter diameter		24.0 mm
Opening angle		180°

Finish

satin chrome look (F1), stainless steel look, other finishes available upon request

Combination

Receiver	Steel frame	TE 645 3D SZ
----------	-------------	--------------

Installation Tools

Jig		Universal milling frame long
Frame, Step 1	Template	No. 5 250945 5
Frame, Step 2	Template	No. 5 250946 5
Door, Step 1	Template	No. 5 250947 5
Door, Step 2	Template	No. 5 250948 5

Functional areas

Fire resistance, Smoke resistance, Soundproof, Burglar resistance

Note

i The load capacity mentioned above refers to the use of 2 hinges per door leaf (1 x 2 m).

Classification key

4	7	9	1	1	4	1	16
---	---	---	---	---	---	---	----

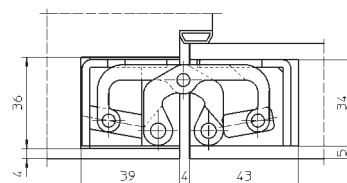
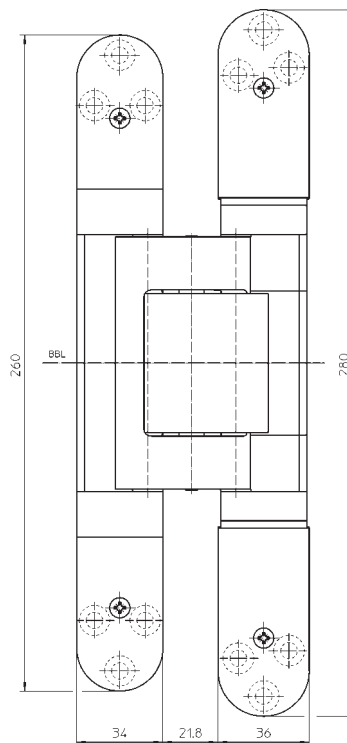



MUSIC THEATRE LINZ

ARCHITECT: Terry Pawson, London

SIMONSWERK: TECTUS® TE 640 3D, TECTUS® TE 640 3D Energy

TECTUS® VERSIONS FOR SPECIAL APPLICATIONS

Special architectural situations, problematic spatial challenges or unusual planning tasks require individual solutions. The solutions presented here by SIMONSWERK complete the TECTUS product range.



TECTUS® Energy

Energy with permanent energy transfer,
load capacities of 40 to 300 kg



TECTUS® FVZ

for constructions with recessed
frame facings, load capacity
up to 100 kg



TECTUS® A8

for doors with claddings up to 8 mm
load capacities of 100 to 160 kg



TECTUS® FR

with integrated intumescent kit
load capacities of 80 to 200 kg

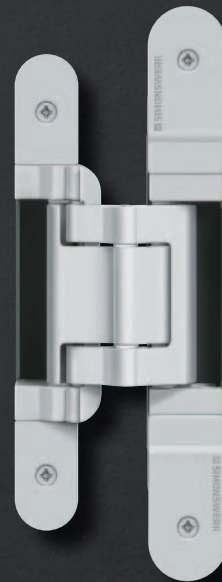

TECTUS® rebated

for rebated doors
load capacity up to 60 kg

TECTUS® ENERGY

ENERGY TRANSFER: INTEGRATED AND PERMANENT

Energy transfer is crucially important in the installation and operation of electric components in high-quality doors. With TECTUS Energy, the door leaf receives a guaranteed and permanent energy supply from the frame, without weakening the structure of either the door or the frame. The technology provided by TECTUS Energy offers compatibility with all the most popular designs for locks and fittings.

UNIVERSAL ADAPTER

- › compatibility with all the most popular designs for locks and fittings
- › three different plug connections (round cable, universal adapter, adapter 1)

CLIP

- › secure connection between cable and hinge housing
- › high functional reliability and fitness for purpose thanks to a closed system

FLAT RIBBON CABLE

- › 16-wire ribbon cable
- › integrated permanent energy transfer
- › entirely enclosed in the housing (closed system)



To find out more about TECTUS Energy download the brochure now at www.simonswerk.com. We will also be happy to send it to you by post.

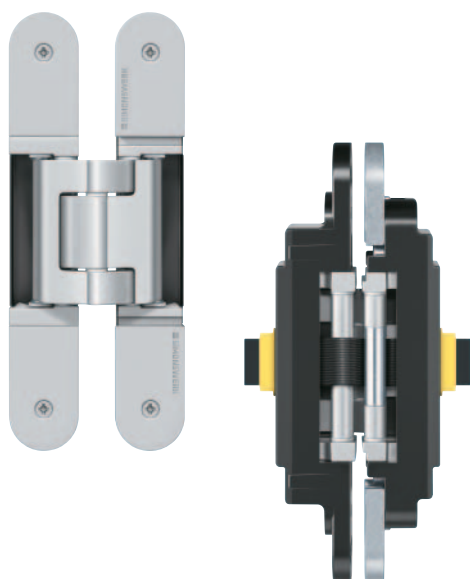

e.g. TE 540 3D Energy

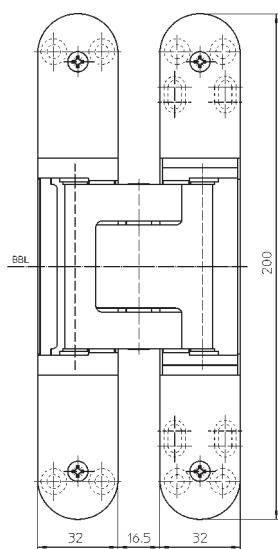

e.g. TE 540 3D Energy

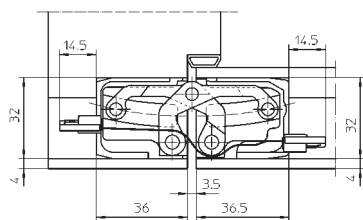

e.g. TE 540 3D Energy

TECTUS Energy

with permanent energy transfer for unrebated doors - with new snap-fitting connection

Hinge	Energy transfer	40 – 300 kg
--------------	------------------------	--------------------

Product features

- with permanent energy transfer
- individual connection adapter options
- completely concealed hinge system
- for timber, steel or aluminium frames
- for unrebated heavy-duty doors
- with comfortable 3D adjustment (side +/- 3.0 mm, height +/- 3.0 mm, compression +/- 1.0 mm)
- maintenance-free slide bearings

Technical Data

No. of wires/wire cross section	16 pieces/0.14 mm ²
Max. voltage	50 V (voltage source acc. SELV-DIN EN 61140)
Max. current	0.8 A (per wire)
Opening angle	180°

Finish

satın chrome look (F1), stainless steel look, other finishes available upon request

Combination

Receiver	Casing frame	TE ... 3D FZ
	Steel frame	TE ... 3D SZ
Accessories	 Round cable	16 x 0,8 A power universal use for all applications cable lengths 3 m or 10 m torsion-proof and snap-fitting connection system
		Universal adapter 3 x 3,2 A and 4 x 0,8 A power for direct connection of different power collectors torsion-proof and snap-fitting connection system
		Adapter 1 3 x 3,2 A and 4 x 0,8 A power special adapter for connecting FUHR motor locks plug-and-play version
		torsion-proof and snap-fitting connection system

Functional areas

Fire resistance, Smoke resistance, Soundproof, Burglar resistance

Note

 The load capacity mentioned above refers to the use of 2 hinges per door leaf (1 x 2 m). Please specify accessories when ordering.

Classification key

4	7	6	1	1	*	1	13
---	---	---	---	---	---	---	----

*depending on the finish

Available options

TE 240 3D Energy	Load capacity up to 40 kg
TE 340 3D Energy	Load capacity up to 80 kg
TE 526 3D Energy	Load capacity up to 120 kg
TE 540 3D Energy	Load capacity up to 120 kg
TE 640 3D Energy	Load capacity up to 200 kg
TE 645 3D Energy	Load capacity up to 300 kg
TE 540 3D A8 Energy	Load capacity up to 100 kg
TE 640 3D A8 Energy	Load capacity up to 160 kg

Detailed information in our PRODUCTSELECTOR at www.simonswerk.com

QUALITY MARKS



FUNCTIONAL AREAS



TECTUS® FVZ

INTEGRATION OF DOOR SET INTO SURROUNDING WALL WITHOUT A VISIBLE FRAME

TE 541 3D FVZ is a new version in which the frame part is offset to the sash part therefore a door with a fully concealed hinge can be integrated into the surrounding wall without any visible frame. The frame facing can be set back by up to 14 mm, to allow the door and wall sets to create a flush-fitting whole.

Load capacity of up to 100 kg



for a 14-mm-recessed frame facing

for a surrounding wall without a visible frame

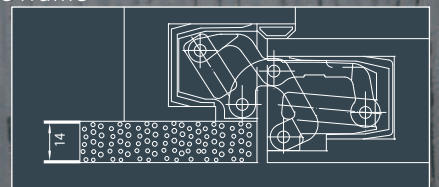



TE 541 3D FVZ

for unrebbated residential and heavy-duty doors with recessed frame facings

Hinge **up to 100 kg**

Product features

- FVZ = 14 mm recessed frame facings
- completely concealed hinge system
- for timber, steel or aluminium frames
- for unrebbated heavy-duty doors
- sideways closed hinge body for a homogeneous mortise appearance
- with comfortable 3D adjustment (side +/- 3.0 mm, height +/- 3.0 mm, compression +/- 1.0 mm)
- maintenance-free slide bearings

Technical Data

Load capacity	i 2 hinges per door leaf (1x2m)	100.0 kg
Overall length		185.0 mm
Width (frame)		28.0/33.0 mm
Width (door)		28.0/32.0 mm
Cutter diameter		24.0 mm
Opening angle		180°

Finish

satın chrome look (F1), stainless steel look, other finishes available upon request

Combination

Receiver	Steel frame	TE 541 3D FVZ SZ
----------	-------------	------------------

Installation Tools

Jig		Universal milling frame
Frame, Step 1	Template	No. 5 250942 5
Frame, Step 2	Template	No. 5 250943 5
Frame, Step 3	Template	No. 5 250682 5
Door, Step 1	Template	No. 5 250942 5
Door, Step 2	Template	No. 5 250943 5
Door, Step 3	Template	No. 5 250944 5

Functional areas

Fire resistance, Smoke resistance, Soundproof

Note

i The load capacity mentioned above refers to the use of 2 hinges per door leaf (1 x 2 m).

Classification key

4	7	5	1	1	*	0	12
---	---	---	---	---	---	---	----

*depending on the finish

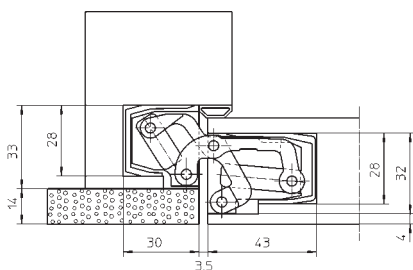
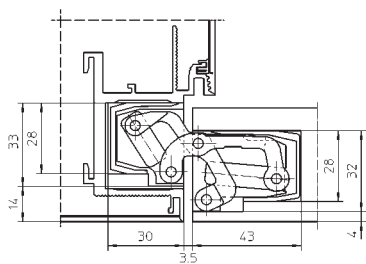
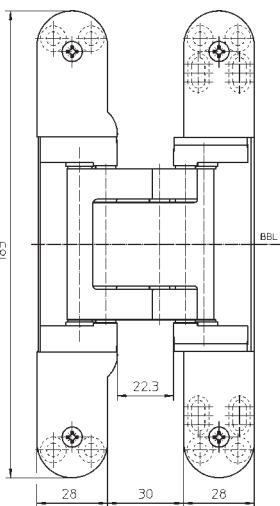

TECTUS® A8 CLADDING ON THE DOOR AND FRAME CONSTRUCTION

“A8” versions provide new application possibilities as they can accommodate cladding of up to 8 mm on the door and frame construction. This gives the designer more scope when integrating the door set into the overall interior design concept.

Load capacity of up to 100 kg

for claddings on door and
frame of up to 8 mm

The use of different materials
such as wood, glass, etc are
possible within door and frame
construction

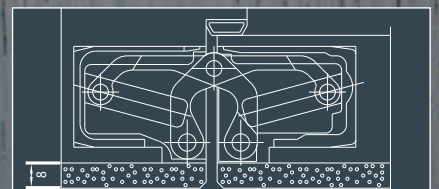



e.g. TE 540 3D A8

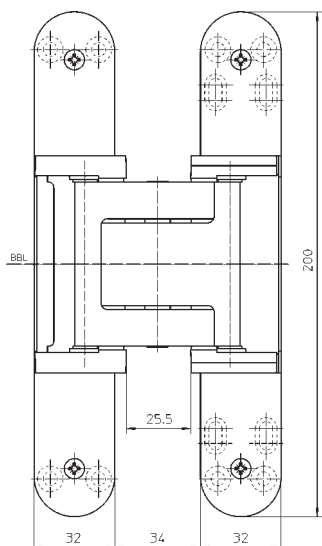

e.g. TE 540 3D A8

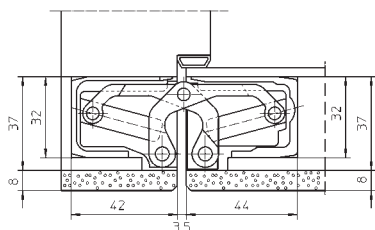

e.g. TE 540 3D A8

TECTUS A8

for unrebated heavy-duty doors with claddings up to 8 mm

Hinge		100 – 160 kg
--------------	--	---------------------

Product features

- claddings up to 8 mm
- completely concealed hinge system
- for timber, steel or aluminium frames
- for unrebated heavy-duty doors
- sideways closed hinge body for a homogeneous mortise appearance
- with comfortable 3D adjustment (side +/- 3.0 mm, height +/- 3.0 mm, compression +/- 1.0 mm)
- maintenance-free slide bearings

Finish

satın chrome look (F1), satin nickel look (F2), stainless steel look, polished brass, polished nickelled, powder-coated, other finishes available upon request

Combination

Receiver	Casing frame	TE ... 3D FZ
	Steel frame	TE ... 3D A8 SZ
Accessories	Cover plate set	TE 540/640 3D A8 radius

Functional areas

Fire resistance, Smoke resistance, Soundproof, Burglar resistance

Note

i The load capacity mentioned above refers to the use of 2 hinges per door leaf (1 x 2 m).

Classification key

4	7	5	1	1	*	1	12a
---	---	---	---	---	---	---	-----

*depending on the finish

Available options

TE 540 3D A8	Load capacity up to 100 kg
TE 640 3D A8	Load capacity up to 160 kg

Detailed information in our PRODUCTSELECTOR at www.simonswerk.com

QUALITY MARKS



FUNCTIONAL AREAS



TECTUS® FR

FIRE RATED WITH INTEGRATED INTUMESCENT KIT

The TECTUS hinge system with integrated intumescent kit protects against fire and smoke escaping into a neighbouring room. In case of a fire or the production of smoke, the intumescent kit swells, sealing the door around the hinges.

Load capacity of 80 - 200 kg

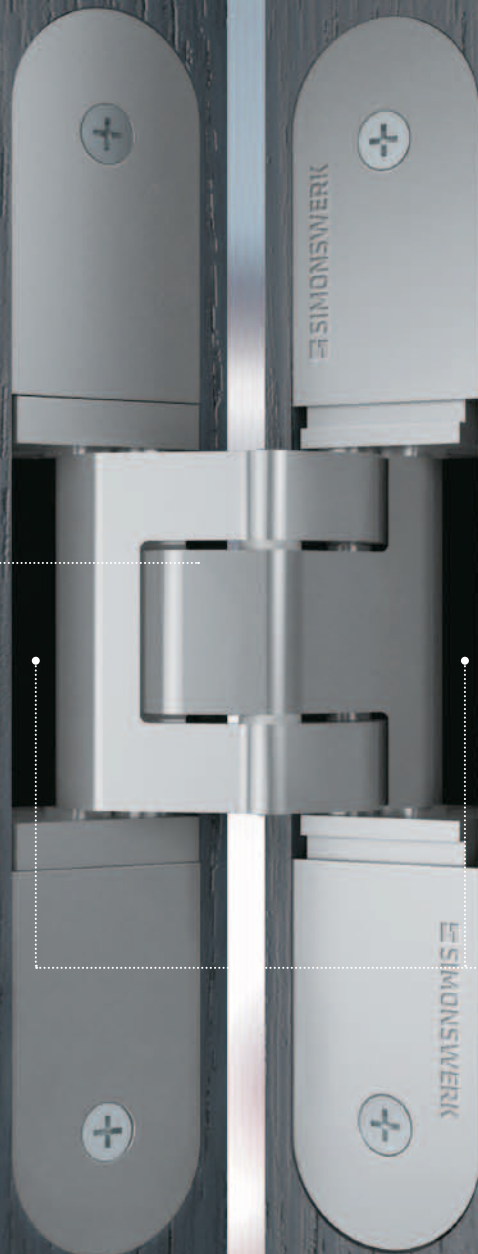

with integrated intumescent kit

The intumescent kit seals the hinge mortise in case of a fire.

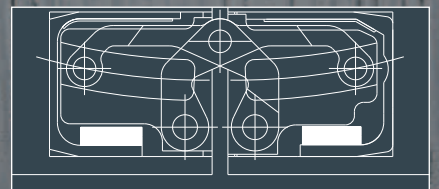



e.g. TE 540 3D FR

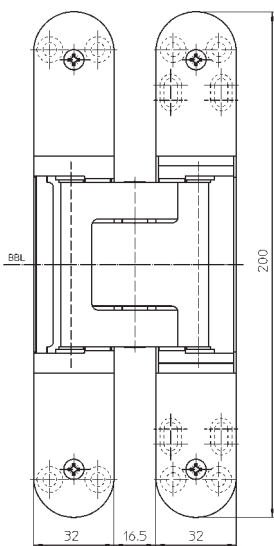

e.g. TE 540 3D FR

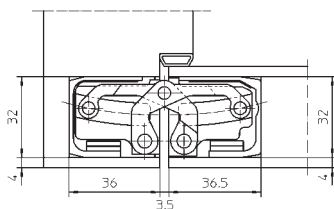

e.g. TE 540 3D FR

TECTUS FR

with integrated intumescent kit for unrebated heavy-duty doors

Hinge	Fire resistance	80 – 200 kg
--------------	------------------------	--------------------

Product features

- with integrated intumescent kit
- completely concealed hinge system
- for timber, steel or aluminium frames
- for unrebated heavy-duty doors
- sideways closed hinge body for a homogeneous mortise appearance
- with comfortable 3D adjustment (side +/- 3.0 mm, height +/- 3.0 mm, compression +/- 1.0 mm)
- maintenance-free slide bearings

Finish

satın chrome look (F1), stainless steel look, other finishes available upon request

Combination

Receiver	Casing frame	TE ... 3D FZ/1
	Steel frame	TE ... 3D SZ

Functional areas

Fire resistance, Smoke resistance, Soundproof, Burglar resistance

Note

i The load capacity mentioned above refers to the use of 2 hinges per door leaf (1 x 2 m).

Classification key

4	7	5	1	1	*	1	13
---	---	---	---	---	---	---	----

*depending on the finish

Available options

TE 340 3D FR	Load capacity up to 80 kg
TE 540 3D FR	Load capacity up to 120 kg
TE 640 3D FR	Load capacity up to 200 kg
TE 540 3D A8 FR	Load capacity up to 100 kg
TE 640 3D A8 FR	Load capacity up to 160 kg

Detailed information in our PRODUCTSELECTOR at www.simonswerk.com

TECTUS® REBATED FOR REBATED RESIDENTIAL DOORS

SIMONSWERK also offer within the TECTUS brand a solution for rebated door leaves. The concealed hinge system is completely invisible when the door is closed. The hinge joint's special geometry allows for installation in the rebated door leaf with a receiver in the wood, steel or aluminium frame.

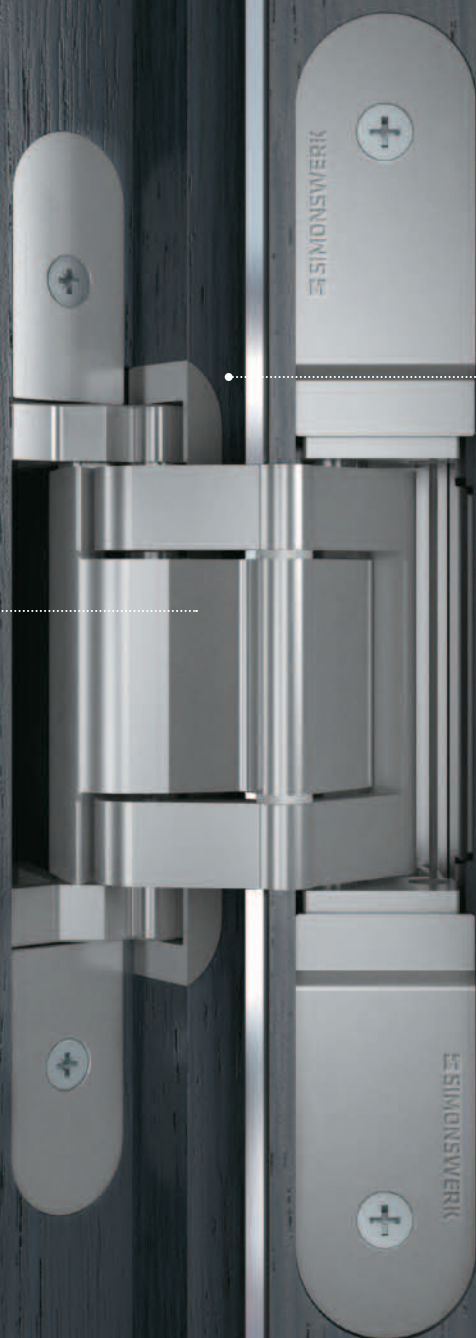

Load capacity up to 60 kg

for rebated residential doors



TE 380 3D

for rebated residential doors

Hinge up to 60 kg

Product features

- completely concealed hinge system
- for timber, steel or aluminium frames
- for rebated residential doors
- sideways closed hinge body for a homogeneous mortise appearance
- with comfortable 3D adjustment (side +/- 3.0 mm, height +/- 3.0 mm, compression +/- 1.0 mm)
- maintenance-free slide bearings

Technical Data

Load capacity	i 2 hinges per door leaf (1x2m)	60.0 kg
Overall length		190.0 mm
Width (frame)		26.0 mm
Width (door)		20.0 mm
Cutter diameter		20.0 mm
Opening angle		180°

Finish

satin chrome look (F1), stainless steel look, other finishes available upon request

Combination

Receiver	Casing frame	TE 380 3D FZ/1
	Steel frame	TE 380 3D SZ

Installation Tools

Jig		Universal milling frame
Frame, Step 1	Template	No. 5 250955 5
Frame, Step 2	Template	No. 5 250956 5
Frame, Step 3	Template	No. 5 250957 5
Door, Step 1	Template	No. 5 250958 5
Door, Step 2	Template	No. 5 250959 5

Note

i The load capacity mentioned above refers to the use of 2 hinges per door leaf (1 x 2 m).

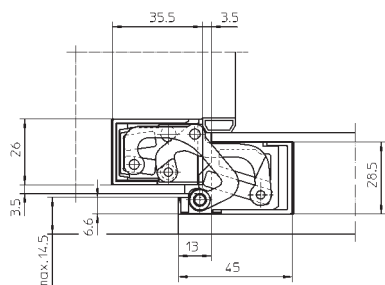
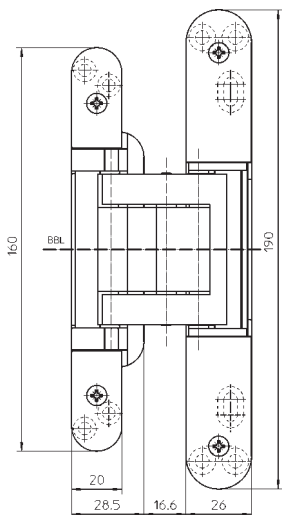

TECTUS®

Fixing plate TECTUS TE ... 3D FZ

for residential and heavy-duty doors with casing frames

Receiver	Casing frame
Finish	
galvanised	
Combination	
Hinge	TE 205 3D TE 240 3D TE 305 3D TE 340 3D TE 380 3D TE 526 3D TE 527 3D TE 540 3D TE 640 3D TE 540 3D A8 TE 640 3D A8
with permanent energy transfer	TE 240 3D Energy TE 340 3D Energy TE 526 3D Energy TE 540 3D Energy TE 640 3D Energy TE 540 3D A8 Energy TE 640 3D A8 Energy
with intumescent kit	TE 340 3D FR TE 540 3D FR TE 640 3D FR TE 540 3D A8 FR TE 640 3D A8 FR

Note

Spacers for casing strengths 22-28 mm are included.
Please specify the exact hinge in your order.

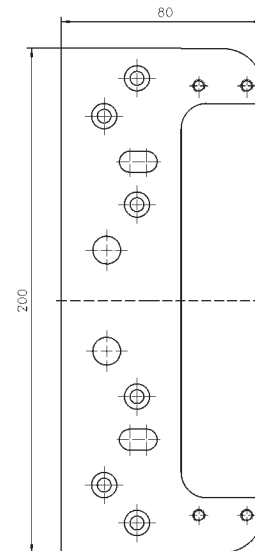
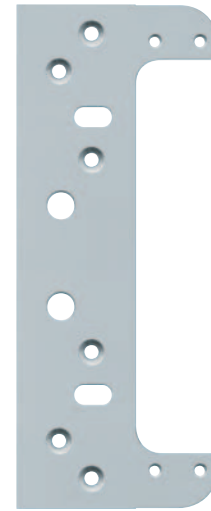

e.g. TE 540 3D FZ

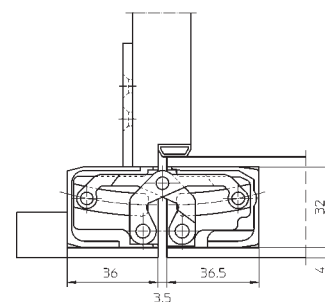

e.g. TE 540 3D with TE 540 3D FZ



Receiver TECTUS TE ... 3D SZ

for residential and heavy-duty doors with steel frames

Receiver	Steel frame
----------	-------------

Finish
galvanised, untreated/raw stainless steel

Combination	
Hinge	TE 205 3D
	TE 240 3D
	TE 305 3D
	TE 340 3D
	TE 380 3D
	TE 526 3D
	TE 527 3D
	TE 540 3D
	TE 541 3D FVZ
	TE 640 3D
	TE 645 3D
	TE 540 3D A8
	TE 640 3D A8
with permanent energy transfer	TE 240 3D Energy
	TE 340 3D Energy
	TE 526 3D Energy
	TE 540 3D Energy
	TE 640 3D Energy
	TE 645 3D Energy
	TE 540 3D A8 Energy
	TE 640 3D A8 Energy
with intumescent kit	TE 340 3D FR
	TE 540 3D FR
	TE 640 3D FR
	TE 540 3D A8 FR
	TE 640 3D A8 FR

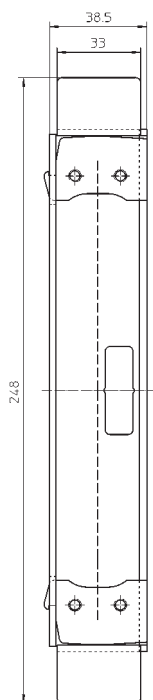

e.g. TE 540 3D SZ

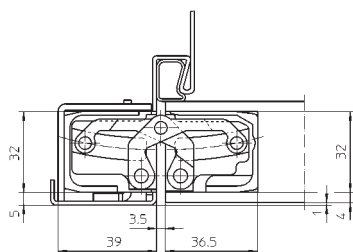

e.g. TE 540 3D with TE 540 3D SZ

Note
Please specify the exact hinge in your order.

TECTUS®

TECTUS series

ASSEMBLY

DOOR

Fix door part with enclosed wood screws.

FRAME

Block frame

Conduct routing according to SIMONSWERK routing data. Use cutter 24 mm Ø (TE 240 3D cutter 16 mm Ø) and collar ring 30 mm Ø. Affix frame part with enclosed wood screws (5 mm Ø).

Casing frame

To guarantee a stable mounting the use of an additional fixing plate is required. Affix the fixing plate by means of appropriate screws (not included) behind the casing. Affix the hinge by using enclosed M5 screws.

Steel frame

Affix frame part of the hinge with the prepared receiver inside the door frame by using the enclosed M5 screws.

Fix cover plates by means of the enclosed screws.

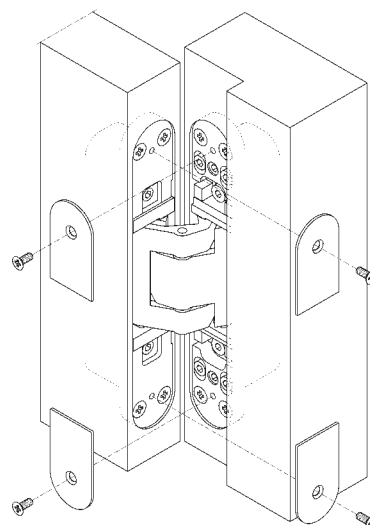
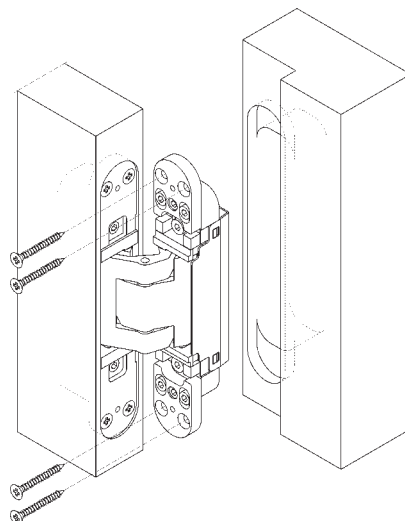
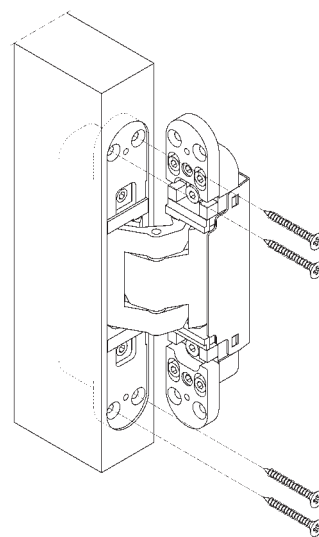

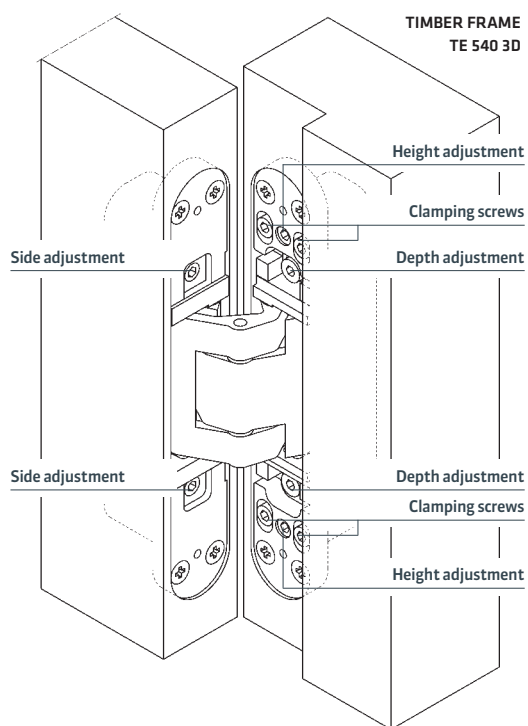

TECTUS series

ADJUSTMENT

Three-dimensionally, continuously adjustable

Side	+/- 3,0 mm
Height	+/- 3,0 mm
Depth	+/- 1,0 mm

Side adjustment

- Adjust the adjusting spindles using a 4 mm Allen key
- Twist left - towards hinge (max. 3 mm)
- Twist right - towards lock (max. 3 mm)

Height adjustment

- Slightly loosen the clamping screws
- Adjust the vertical position of the door by turning the lower height adjustment screw (turn the upper height adjustment screw in the opposite direction if necessary).
- Retighten the clamping screws

Depth adjustment

- Slightly loosen the fixing screws
- Put the door to the correct compression
- Retighten the clamping screws

All adjustments to be conducted by means of a 4 mm Allen key

TECTUS®

TE 540 3D Energy

(exemplary illustration)

CALCULATION FORMULAS

A = Depth of frame rebate up to sealing

B = Thickness of door leaf resp. 1st door rebate

 $A - B + 4 = \text{Measure X}$

The result has to be a measure between 4.0 mm and max. 6.0 mm. (Steel frame: X = 5.0 mm)

Conduct routing with cutter $\varnothing 24$ mm, collar ring $\varnothing 30$ mm and universal milling frame with template No. 5 250680 5 (step 1), template No. 5 250681 5 (step 2) and template No. 5 250939 5 (additional routing Energy).

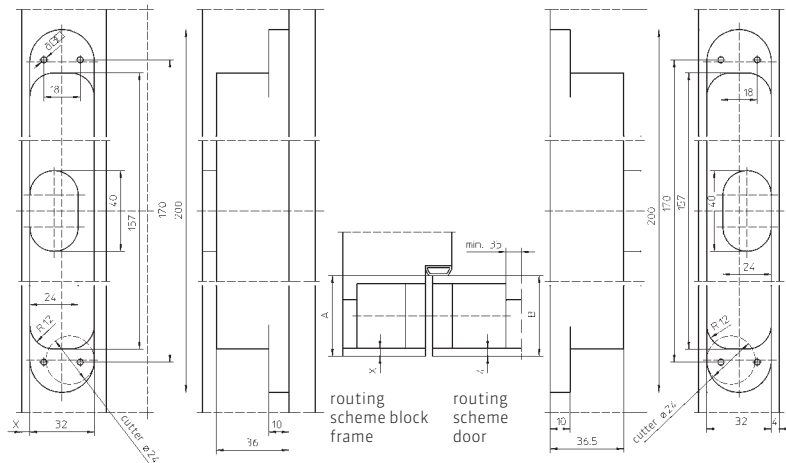

TE 541 3D FVZ

ROUTING DATA

Conduct routing with cutter $\varnothing 24$ mm, collar ring $\varnothing 30$ mm and universal milling frame with template No. 5 250942 5 (frame, step 1), template No. 5 250943 5 (frame, step 2), template No. 5 250682 5 (frame, step 3), template No. 5 250942 5 (door, step 1), template No. 5 250943 5 (door, step 2) and template No. 5 250944 5 (door, Step 3).

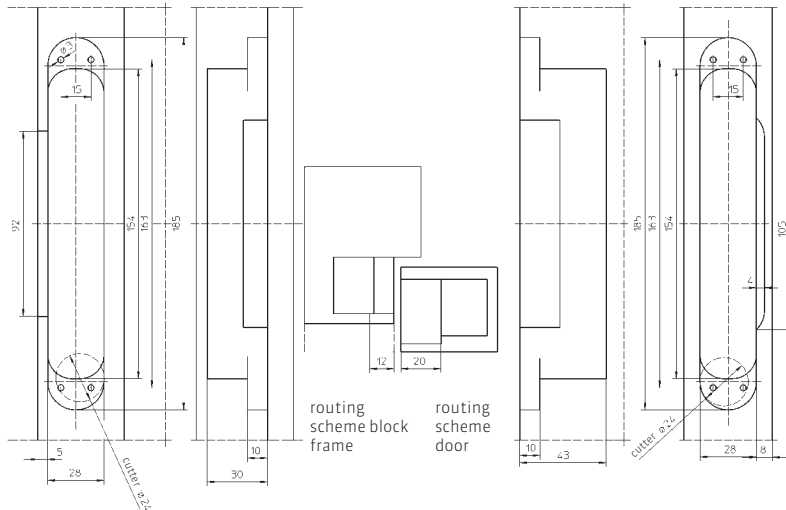
TE 540 3D A8 /
TE 540 3D A8 FR

ROUTING DATA

Conduct routing with cutter $\varnothing 24$ mm, collar ring $\varnothing 30$ mm and universal milling frame with template No. 5 250680 5 (Step 1), template No. 5 250681 5 (Step 2) and template No. 5 250682 5 (Step 3).

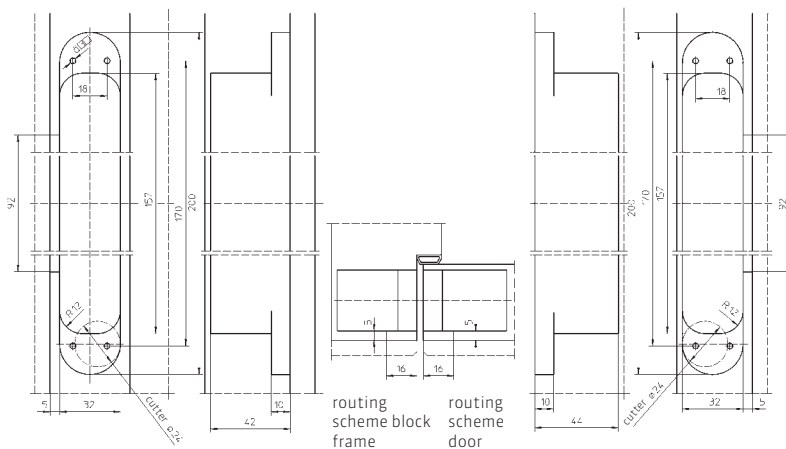

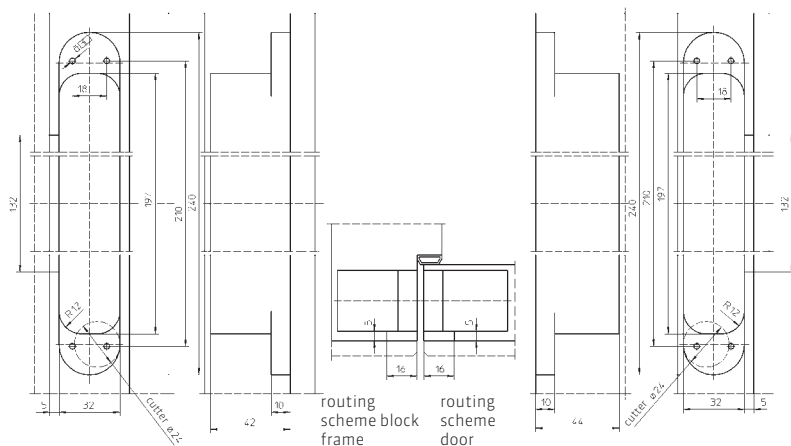

TE 640 3D A8 / TE 640 3D A8 FR

ROUTING DATA

Conduct routing with cutter Ø 24 mm, collar ring Ø 30 mm and universal milling frame with template No. 5 250659 5 (Step 1), template No. 5 250689 5 (Step 2) and template No. 5 250690 5 (Step 3).

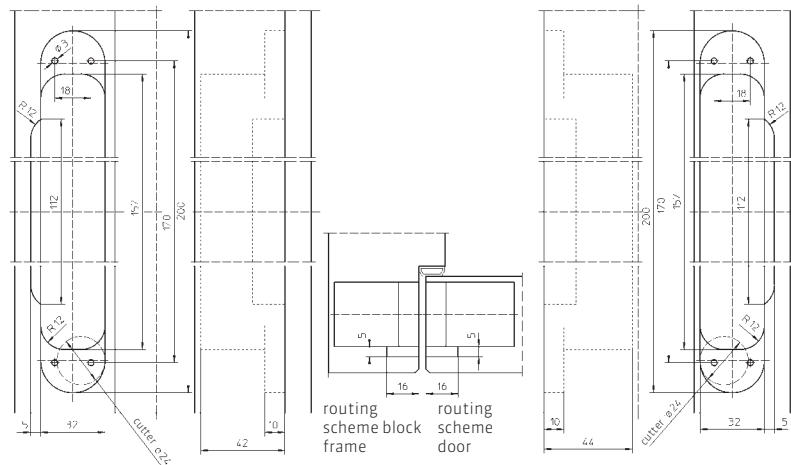

TE 540 3D A8 (without cladding)

ROUTING DATA

Conduct routing with cutter Ø 24 mm, collar ring Ø 30 mm and universal milling frame with template No. 5 250680 5 (Step 1), template No. 5 250681 5 (Step 2) and template No. 5 250687 5 (Step 3).

TECTUS®

TE 640 3D A8 (without cladding)

ROUTING DATA

Conduct routing with cutter Ø 24 mm, collar ring Ø 30 mm and universal milling frame with template No. 5 250659 5 (Step 1), template No. 5 250689 5 ((Step 2) and template No. 5 250688 5 (Step 3).

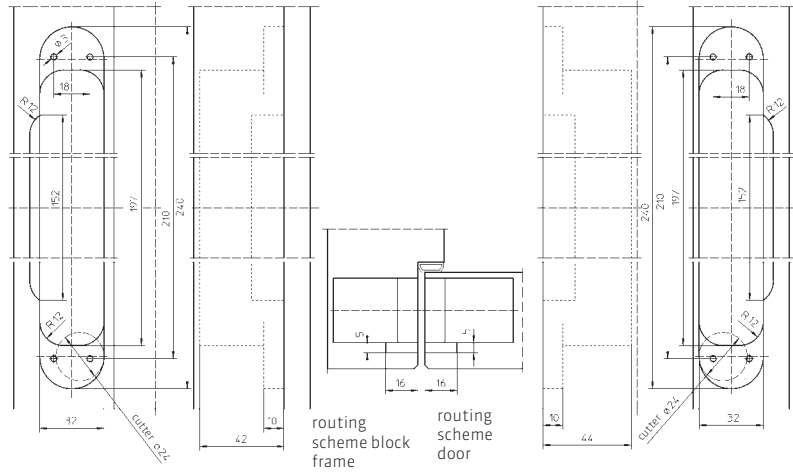

TE 380 3D

ROUTING DATA

Conduct routing with cutter Ø 20 mm, collar ring Ø 30 mm and universal milling frame with template No. 5 250955 5 (frame, step 1), template No. 5 250956 5 (frame, step 2), template No. 5 250957 5 (frame, step 3), template No. 5 250958 5 (door, step 1) and template No.5 250959 5 (door, step 2).

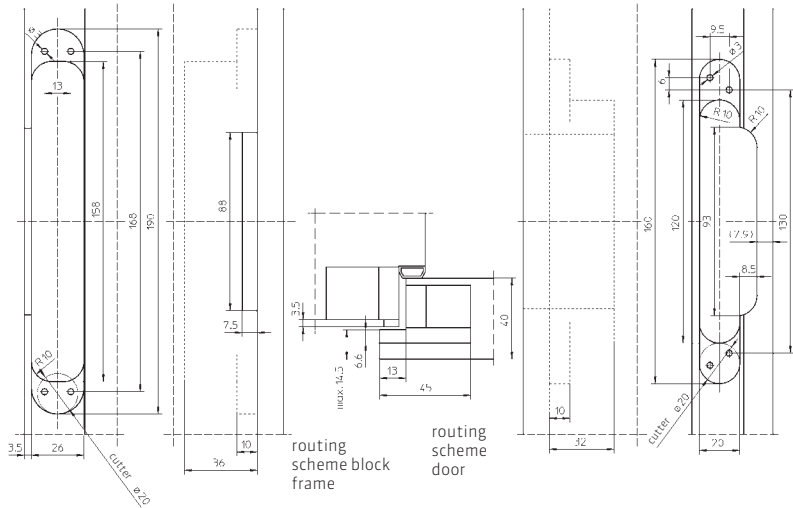

SERVICE – COMPREHENSIVE EXPERTISE FOR YOUR DAILY WORK

We are happy to provide you with all the documentation you need to calculate which is the most suitable hinge system for your requirements. Please contact us: we would be delighted to work with you to choose the best solution – from high-quality standard sets right up to the most complex solutions.

Please visit our home page for any information not included in this brochure. You will find it easy to navigate through our user-friendly website to arrive at the detailed, comprehensive solutions.

All our brochures and data sheets can be requested in a printed version, or you can simply download them on the spot – and the same applies to our fitting instructions and milling data.

VISIT OUR PRODUCT SELECTOR

Whether you are a manufacturer, trade partner or designer, at www.simonswerk.com you can find precise, detailed product descriptions that will help you to choose the most suitable hinge systems.



You are here: Productselector

quick search

brand

topic

novelties

scope of application

- heavy-duty door
- residential door
- entrance door
- window
- metalworking

function range

- finger protection
- fire resistance, smoke resistance
- soundproof
- burglar resistance

product type

- hinge
- cover angle
- accessories
- receiver

type of door

- timber
- metal
- glass
- PVCu
- aluminium

rebate

- rebated
- rebated flus
- unrebated

CONTAINS

TE 240 3D	TECTUS® Energy
TE 340 3D	TECTUS® FVZ
TE 526 3D	TECTUS® A8
TE 527 3D	TECTUS® FR
TE 540 3D	TECTUS® rebated
TE 640 3D	
TE 645 3D	

PLEASE VISIT OUR PRODUCTSELECTOR ON:
www.simonswerk.com



SIMONSWERK GmbH

Bosfelder Weg 5
33378 Rheda-Wiedenbrück
Germany

Fon +49 (0)5242/413-0
Fax +49 (0)5242/413-260

sales@simonswerk.de
www.simonswerk.com

